

*Cirencester
Community
Railway
Project*

Linking Cirencester with the National Network
Easy Access to Swindon, Gloucester, London ...
... the UK, Europe, the World !

Cirencester Community Railway An Overview

- 1. Introduction and History**
- 2. Reasons to Re-open the Route**
- 3. Benefits of a Rail Service**
- 4. Why Very Light Rail?**
- 5. The Route**
- 6. Key Points on the Way**
- 7. Progress Update**
- 8. What Next?**



Cirencester Community Railway An Overview

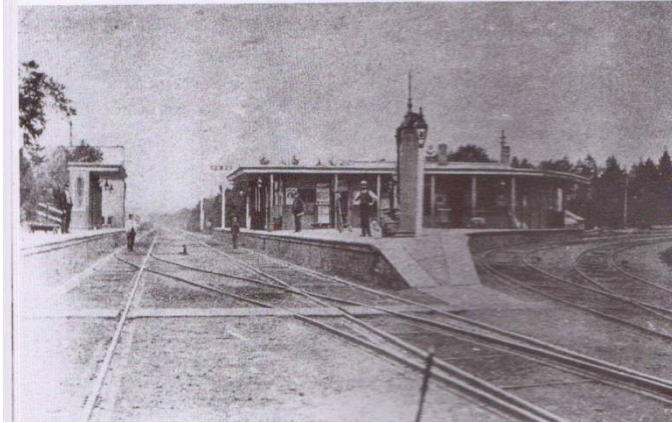

Opened 1841



Reduced Service in 1959

Closed in 1964-5 due to Beeching

Cirencester Community Railway

The Benefits to Cirencester and Its Economy

- Regular service scheduled to align with trains
- No waiting at Kemble for bus or taxi
- Access for residents, visitors and business
- Enhanced image and competitiveness
- Increased conference/meeting opportunities
- Local roots with countywide presence
- Connectivity boost for Cotswold economy
- **Environmental enabling infrastructure**
- **Encourages Modal Shift from cars**

Sustainable Long-term Solution!



Cirencester Community Railway Reasons – Now is the Time

- Expanding Population of Cirencester – Chesterton Development 2350 homes
- Re-doubling of the Main Line through Kemble – more train services
- **Government Awareness of Climate Crisis – Time is running out**

Sustainable Long-term Solution!

Cirencester Community Railway

Advantages of Very Light Rail

- Battery Powered - Zero Carbon potential in Operation
- Lower Infrastructure Cost than Train or Tram
- Little disturbance of buried services
- Low platform cost
- 120 year track life - Long-term Environmental Benefits
- No pollution, no 'Oslo Effect' particulates
- Minimises Dependence on Cars - Reduces Congestion
- Reliable and Available
- Uses Existing Technology - Shovel Ready Concept

Maximum Next-Generation Benefit

Cirencester Community Railway The Electric Vehicle - Very Light Rail



Under development by
WMG, Warwick.
20 seats, 70 standing.
Testing at Dudley in the
spring.

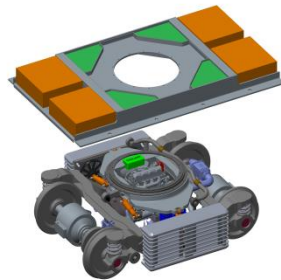

Cirencester Community Railway Very Light Rail Environmental Credentials

- Better than bus
- Much better than electric car – lower manufacturing impact
- Better even than tram – lower track construction impact

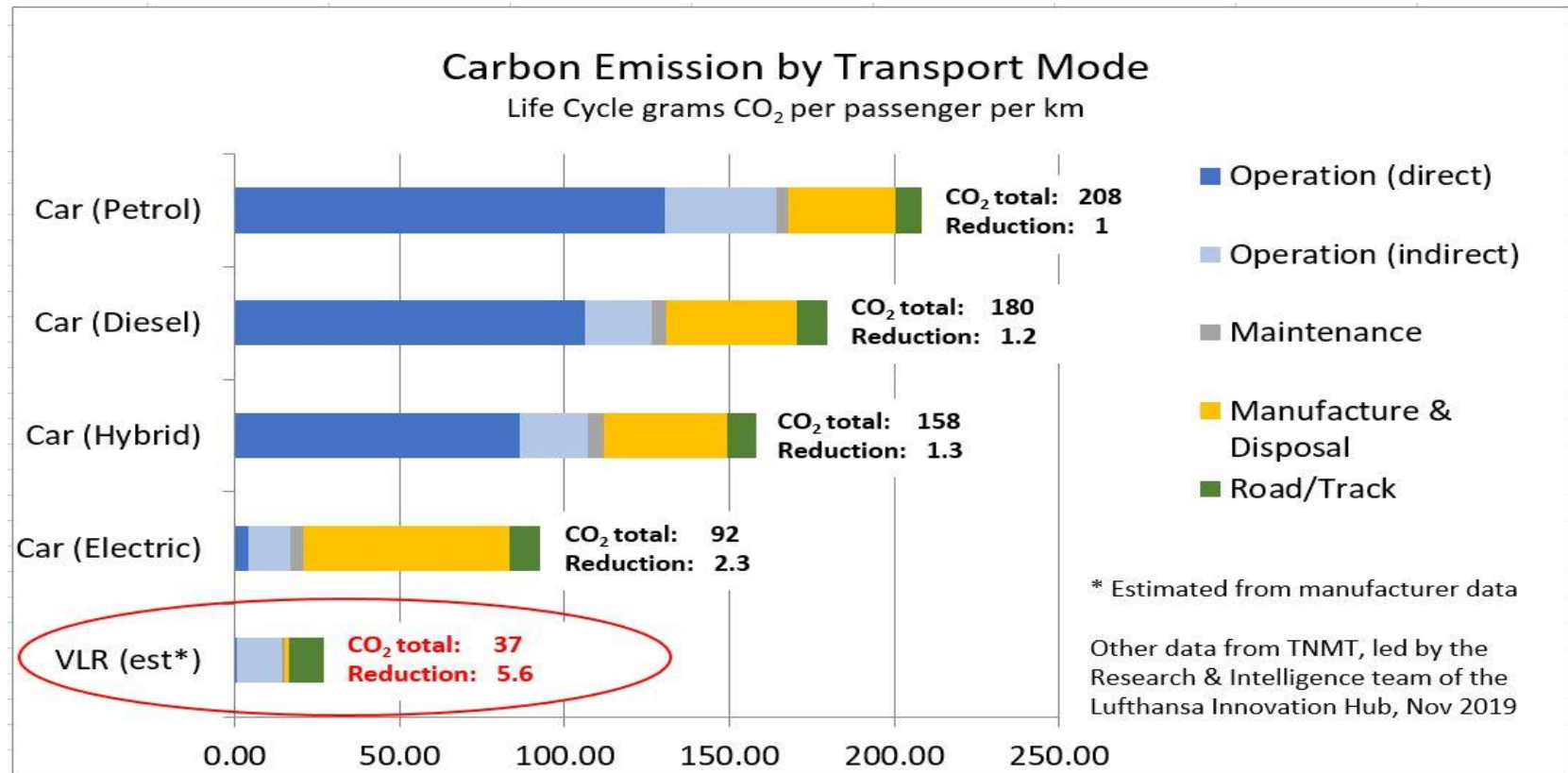

Cirencester Community Railway

The Route Overview

The battery-powered Shuttle will follow the original alignment as far as is practical, then turning toward the RAU.

The University Station and its car park will serve the RAU and the Chesterton development, as well as Cirencester College and Deer Park.

The line will extend into the town finishing at Town Halt near the original station, close to the Market place, businesses, Museum and Leisure Centre.

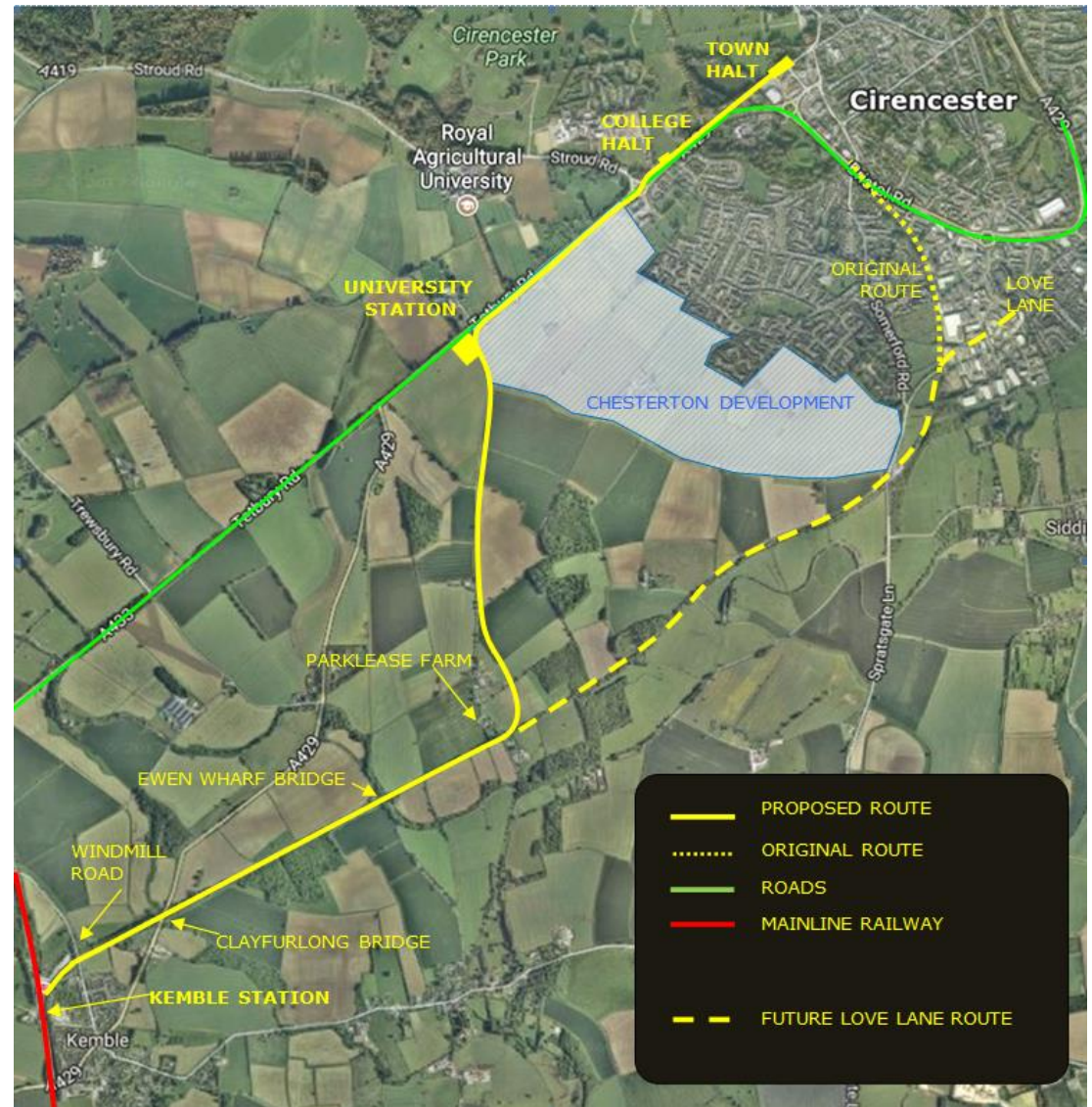

Cirencester Community Railway The Route – Kemble Station

The Shuttle will use the old 'Cirencester' platform at Kemble Station, run across the car park and will cross Windmill Road 'at grade' (level crossing).

Then it will need a new bridge to cross the A429.

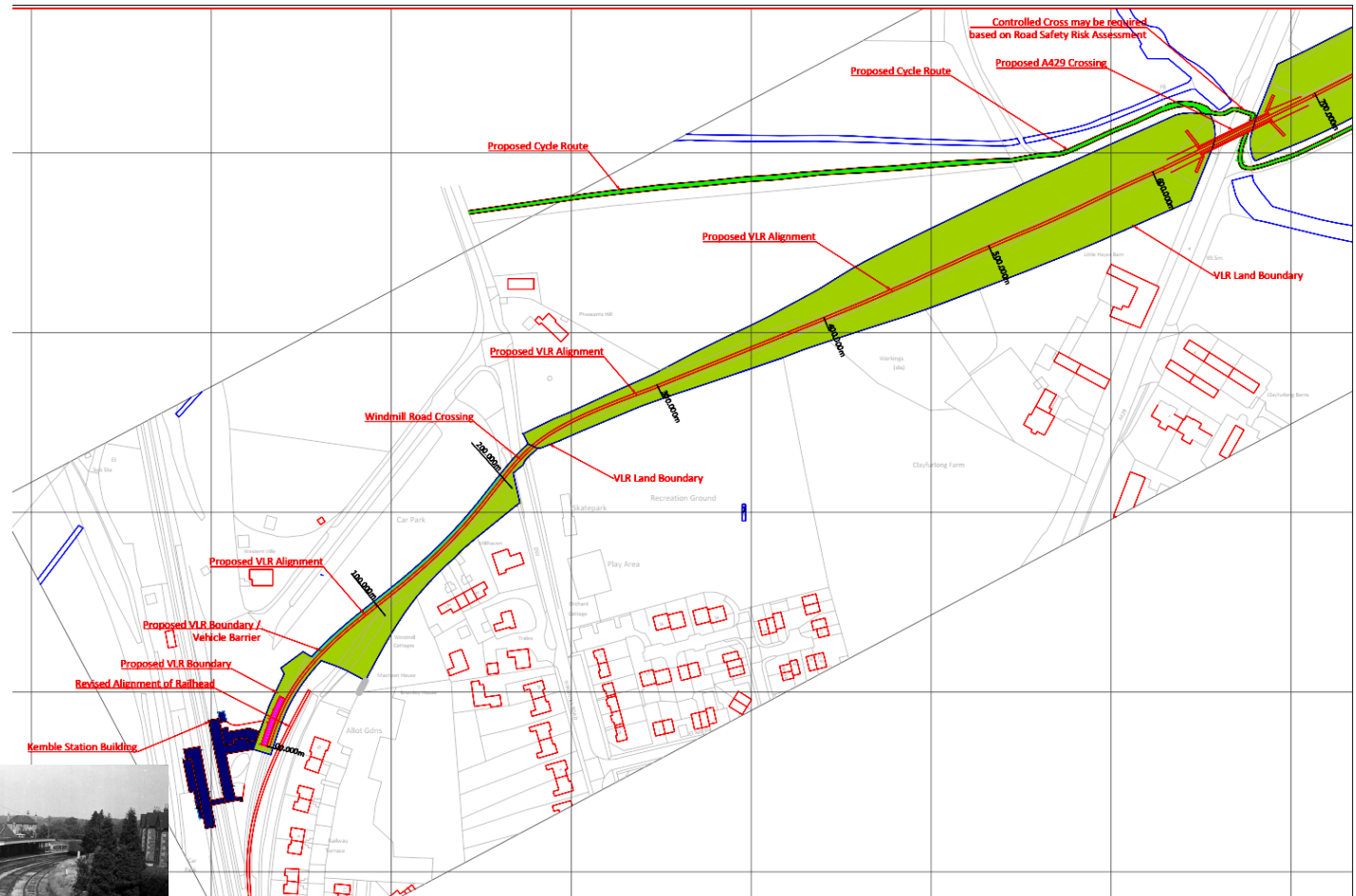

Cirencester Community Railway The A429 Clayfurlong Bridge

The light weight of the VLR means that a slender elegant bridge can be used.

The total span is about 70m, with the central span being about 40m.

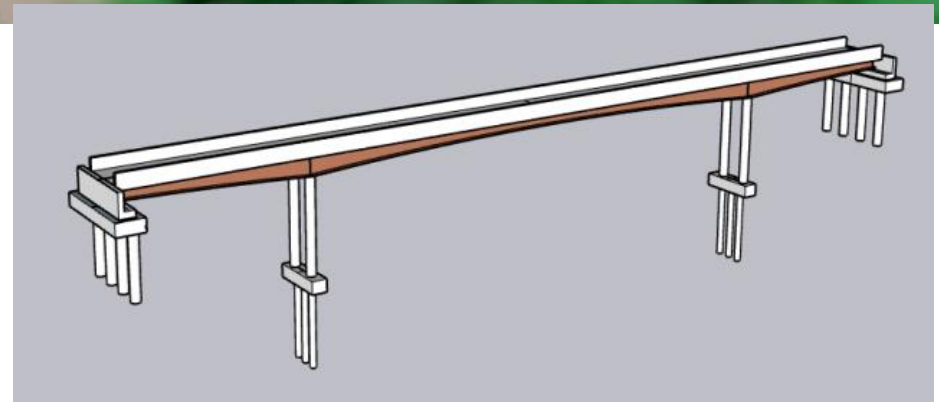

Cirencester Community Railway The Route Overview

The route follows the 'original alignment'



as far as Park Lease,



then swings left to cross open land towards the RAU.

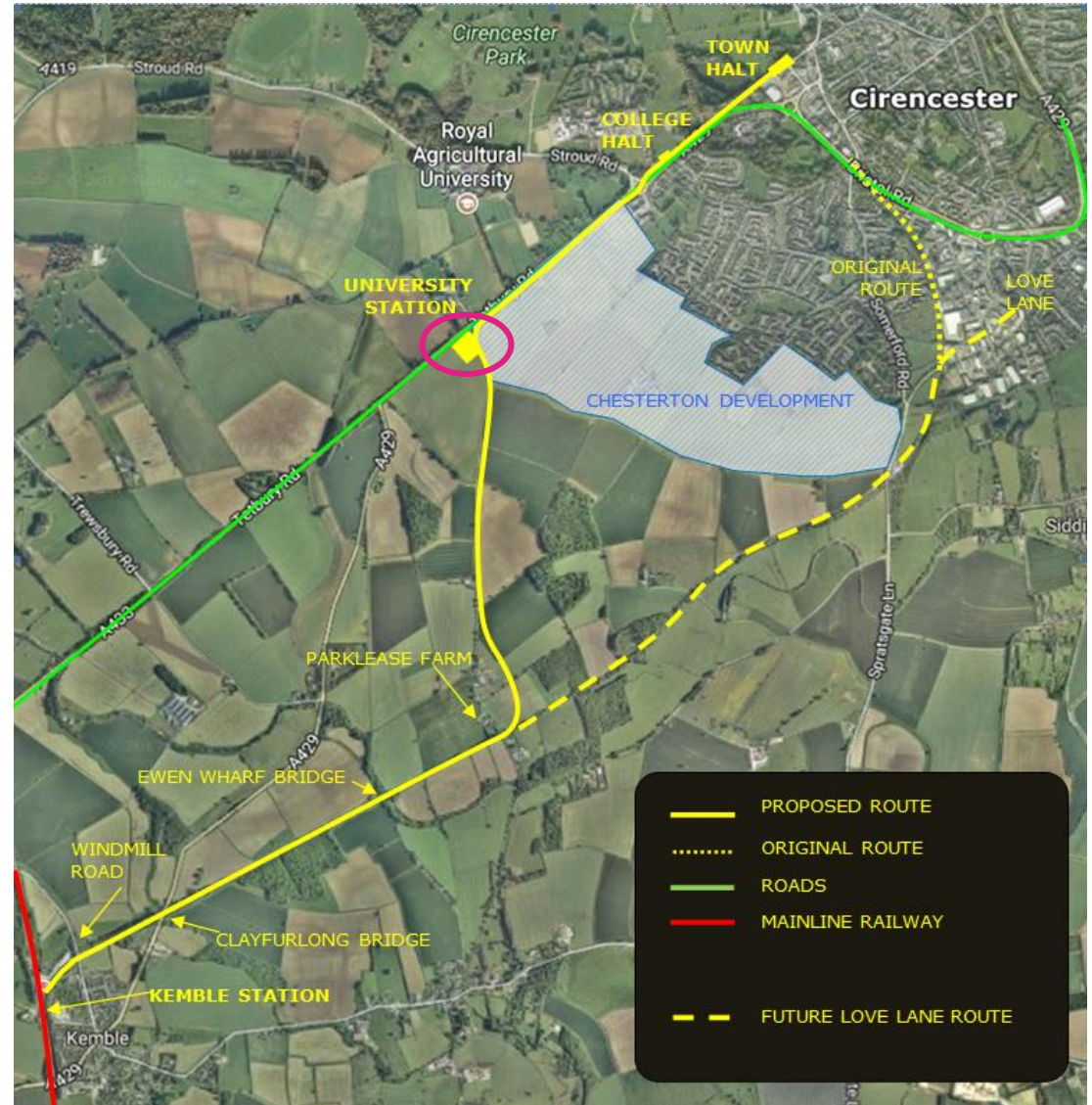

Cirencester Community Railway The Route – University Station

The Shuttle's service shed and car park will be located at the University Station opposite the College Workshops entrance.

This will include the main platforms and a passing loop to allow multiple trains.

The large car park forms a Park-and-Ride opportunity.

Then the route follows the Tetbury Road beside the Chesterton development.

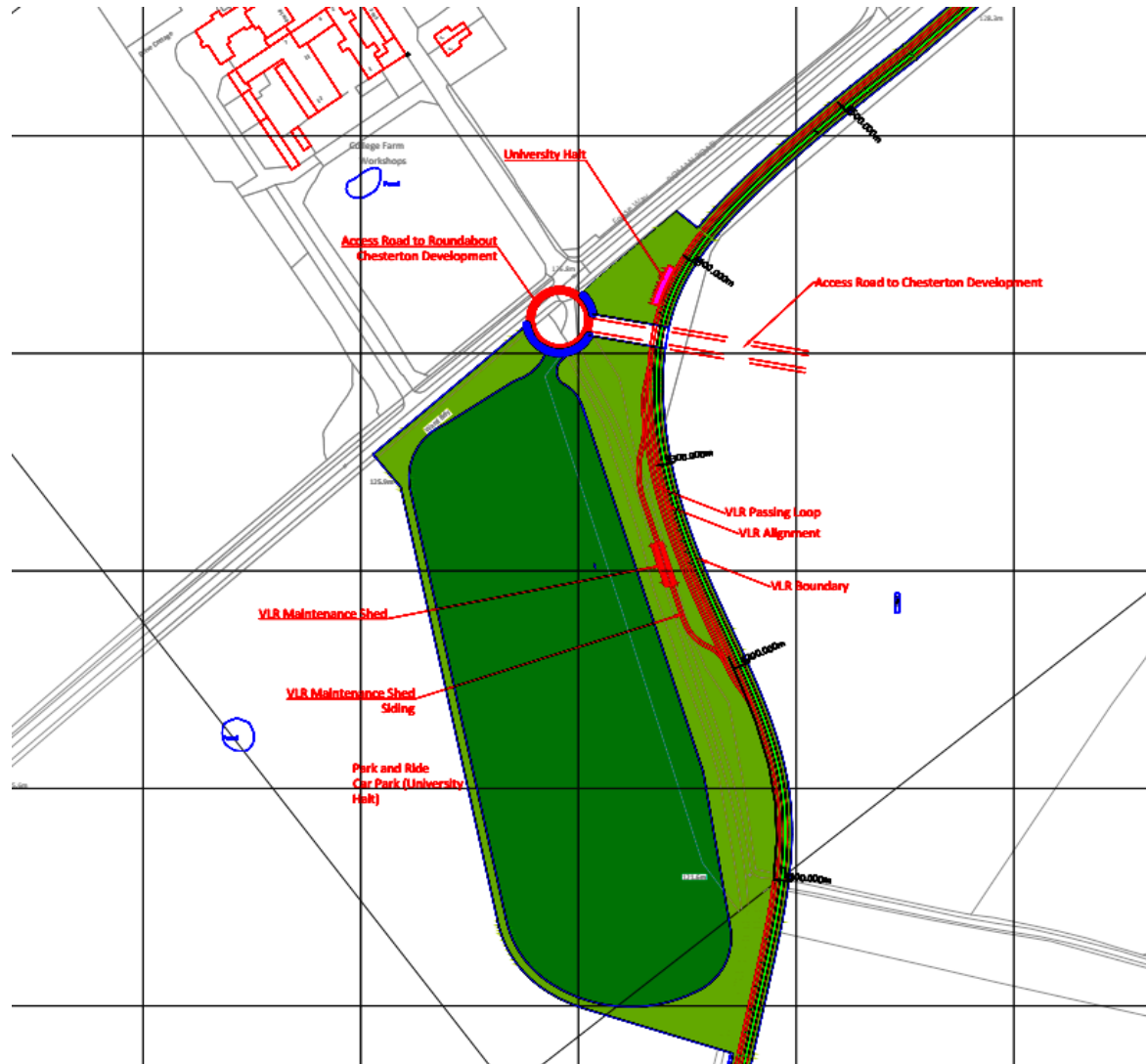

Cirencester Community Railway The Route – University Gate

The route follows the Tetbury Road on the southeast side to the Stroud Road roundabout.

This will also support the proposed University Gate Technology Park

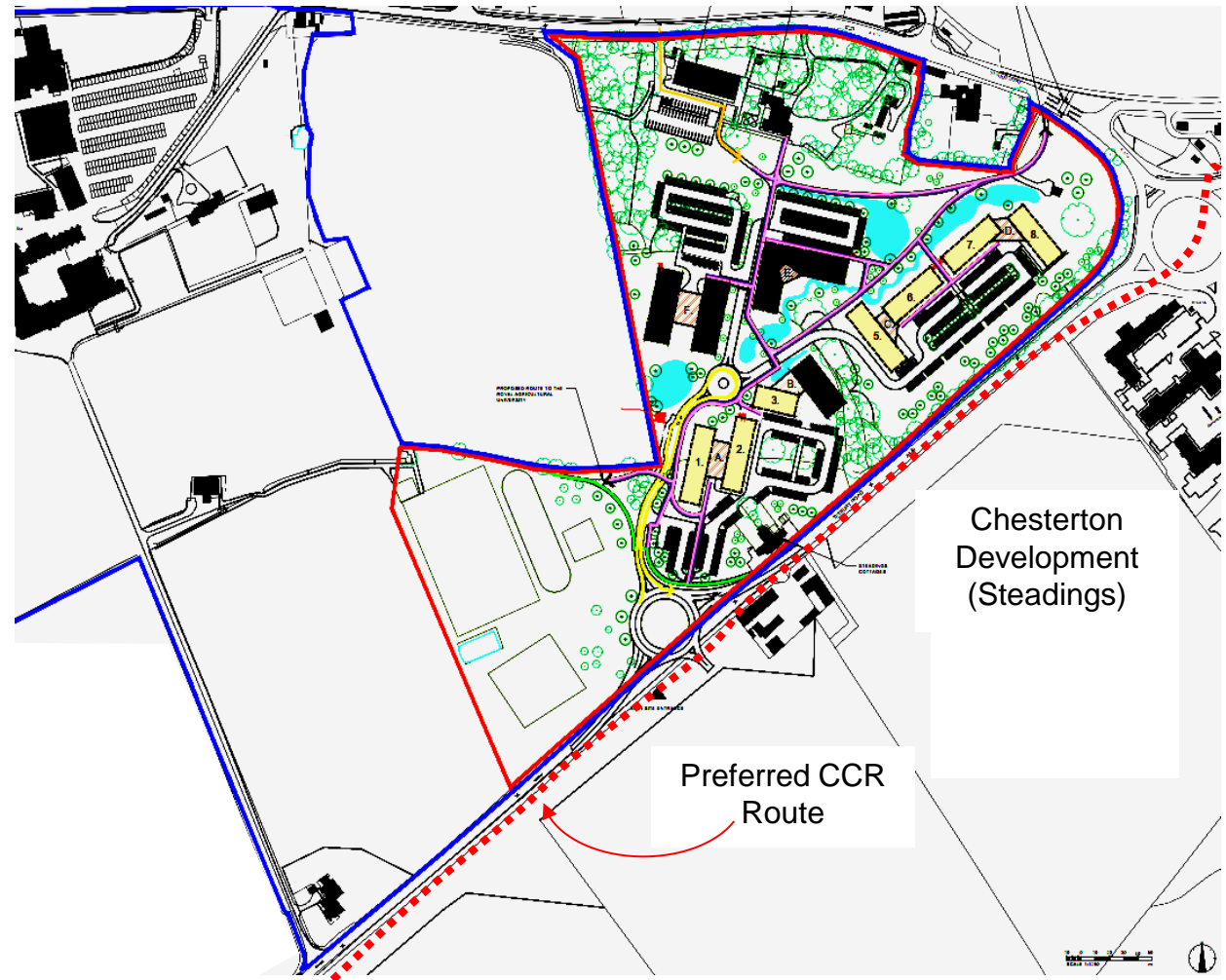

Cirencester Community Railway Route Detail - Stroud Road Roundabout

To avoid the congested area along the Old Tetbury Road, the route will stay on the south-east side of the A429, then cross the middle of the roundabout and follow the north-east side of the road for the remainder of the journey.

This also minimises the disruption to road traffic by combining the two road crossings into one.

Tram-over-roundabout junctions have been used successfully in many places from Amsterdam to Morocco.

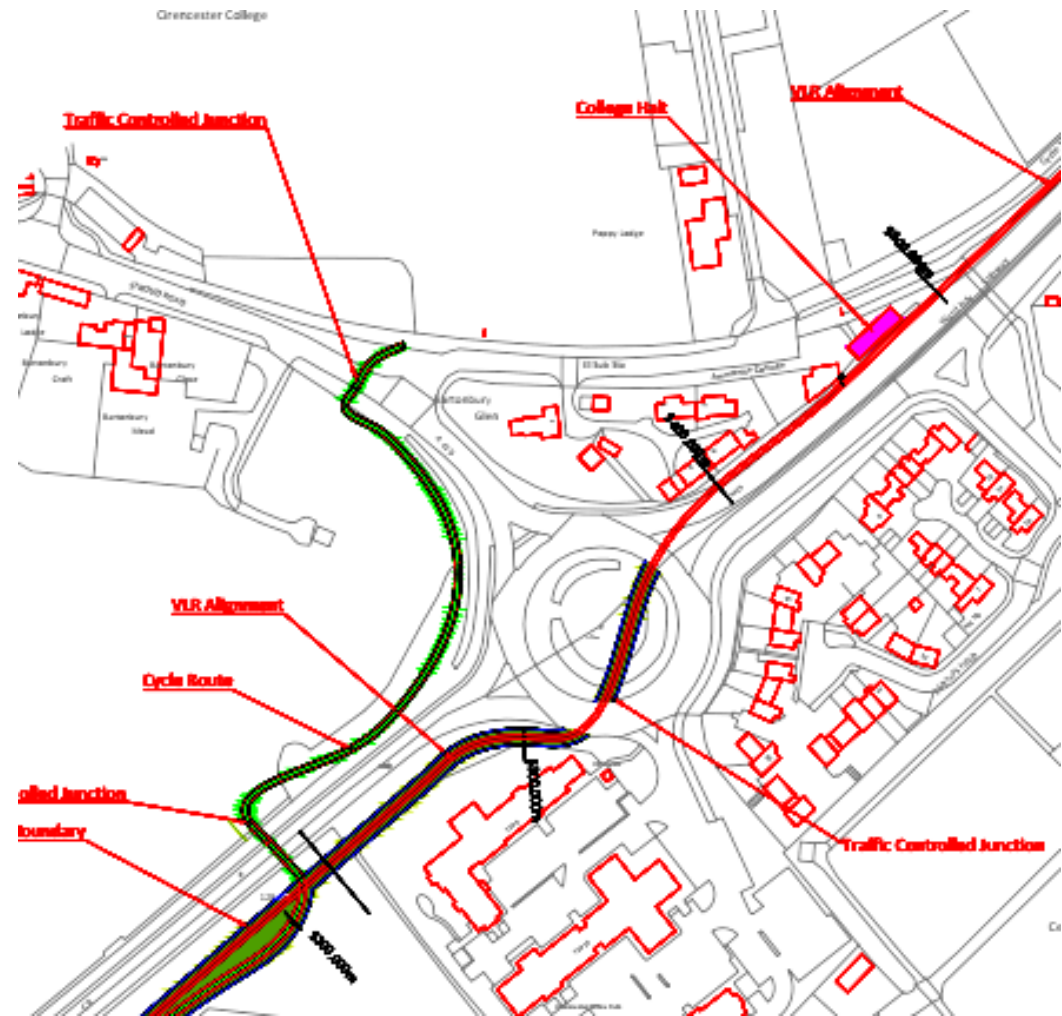

Cirencester Community Railway Route Detail – Town Halt

The proposed Town Halt is opposite the Old Station Car Park, close to SJP, 350 steps from the Market Place and with easy access from the dual carriageway - ideally located for bus/transport hub?

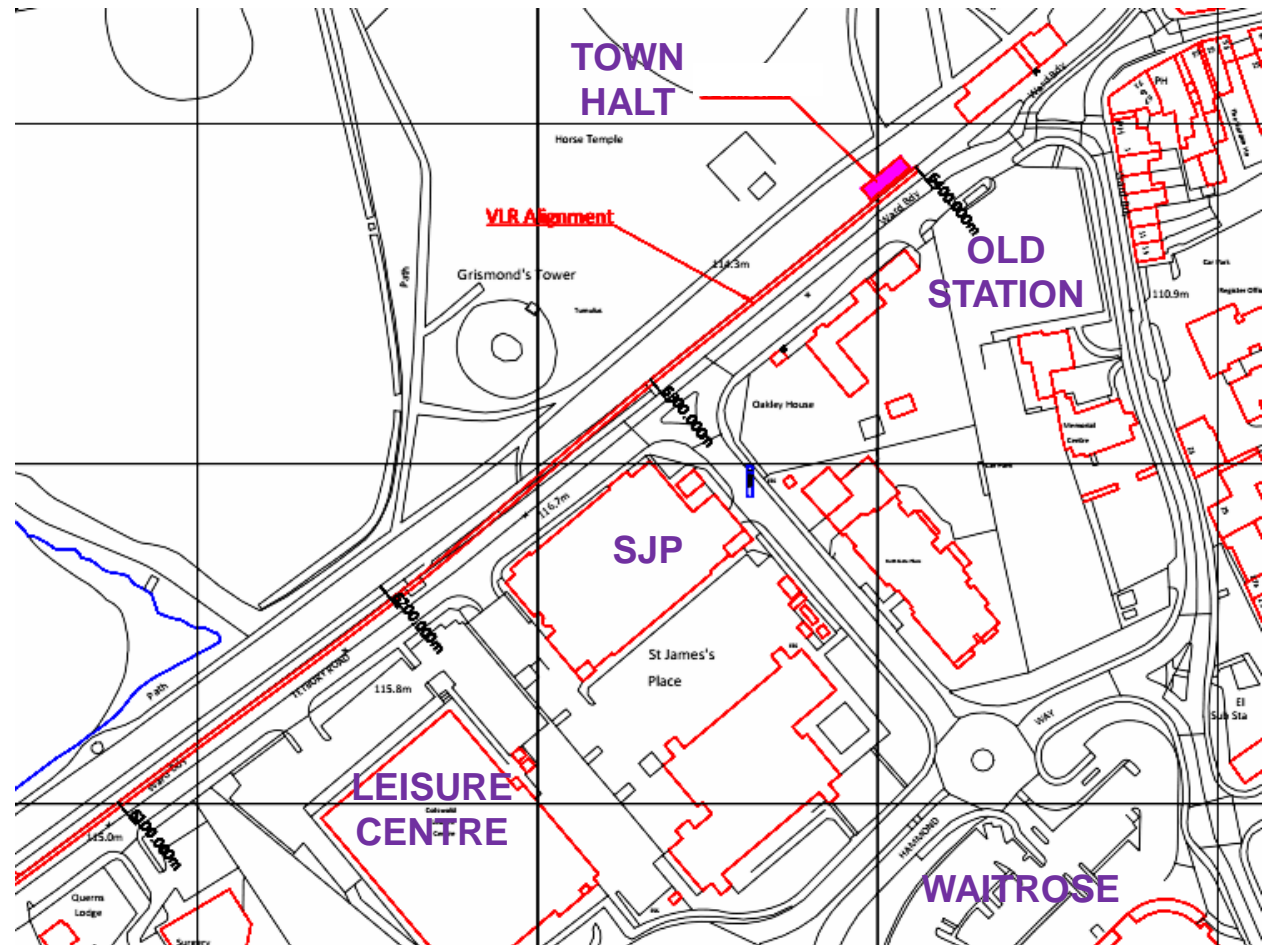

Cirencester Community Railway

The Dream of Integrated Transport

The majority of the route is wide enough, so a cycle and walking path is included in the plan, alongside the track.

CCRP is in favour of a bus station on the Old Station Car Park, accessible by pedestrians and buses.

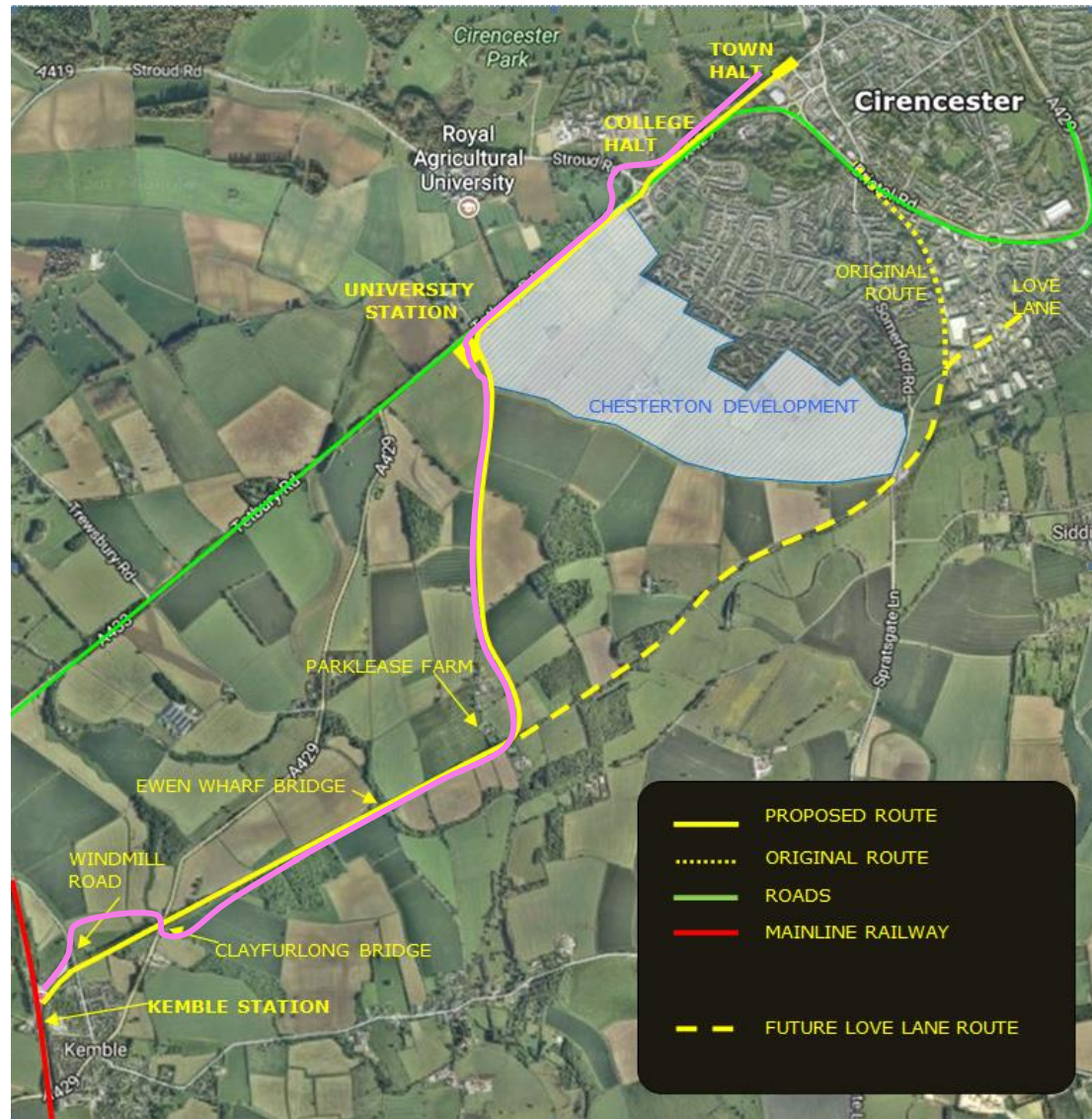
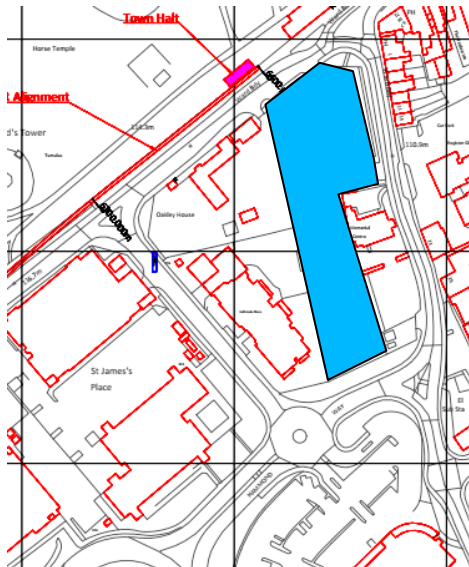

Cirencester Community Railway

Current Status

Feasibility Study Phases :

- ✓ Preliminary – Check for show-stoppers – completed, all clear 1 month
- Primary – Develop business case and assemble evidence for formal application – almost completed : 4 months
- Secondary – Complete outline design, accurate costings ready for construction, prepare for Transport and Works Act Application : 9 months

Cirencester Community Railway Feasibility Study Highlights

Aspects Addressed in Primary Phase :

- Route – best route identified
- Geotechnical – foundation structure is sound
- Environmental – no conflict with protected species
- Structure – bridges and crossings all understood
- Safety – preliminary risk analysis passed
- Integrated Transport – networks well with buses & cyclists
- Support – letters of support from RAU, Bathurst Estate and Network Rail

Cirencester Community Railway

The Future

Next Issues to Address :

- Estimated patronage figures after lockdown: traveller and public surveys not possible, but theoretical analysis available
- Agree details of route with landowners and CDC
- Funding – invited by DfT: ‘ready to work with you on how best to take this project to the next stage and invite you to discuss the next steps’ ***Newsflash!***

Cirencester Community Railway Summary

Current Position :

- Leading the way for low-cost Very Light Rail solutions to link towns across the UK
- In tune with Green Cirencester's awareness of the importance of the environment
- In step with the Government's plans for Green Transport Infrastructure and Integrated Transport Solutions

visit CirenTrain.org.uk for more information

Cirencester Community Railway ... and after that...?

Requests for lines to Love Lane, The Water Parks,
Cotswold Airport, Tetbury, ...

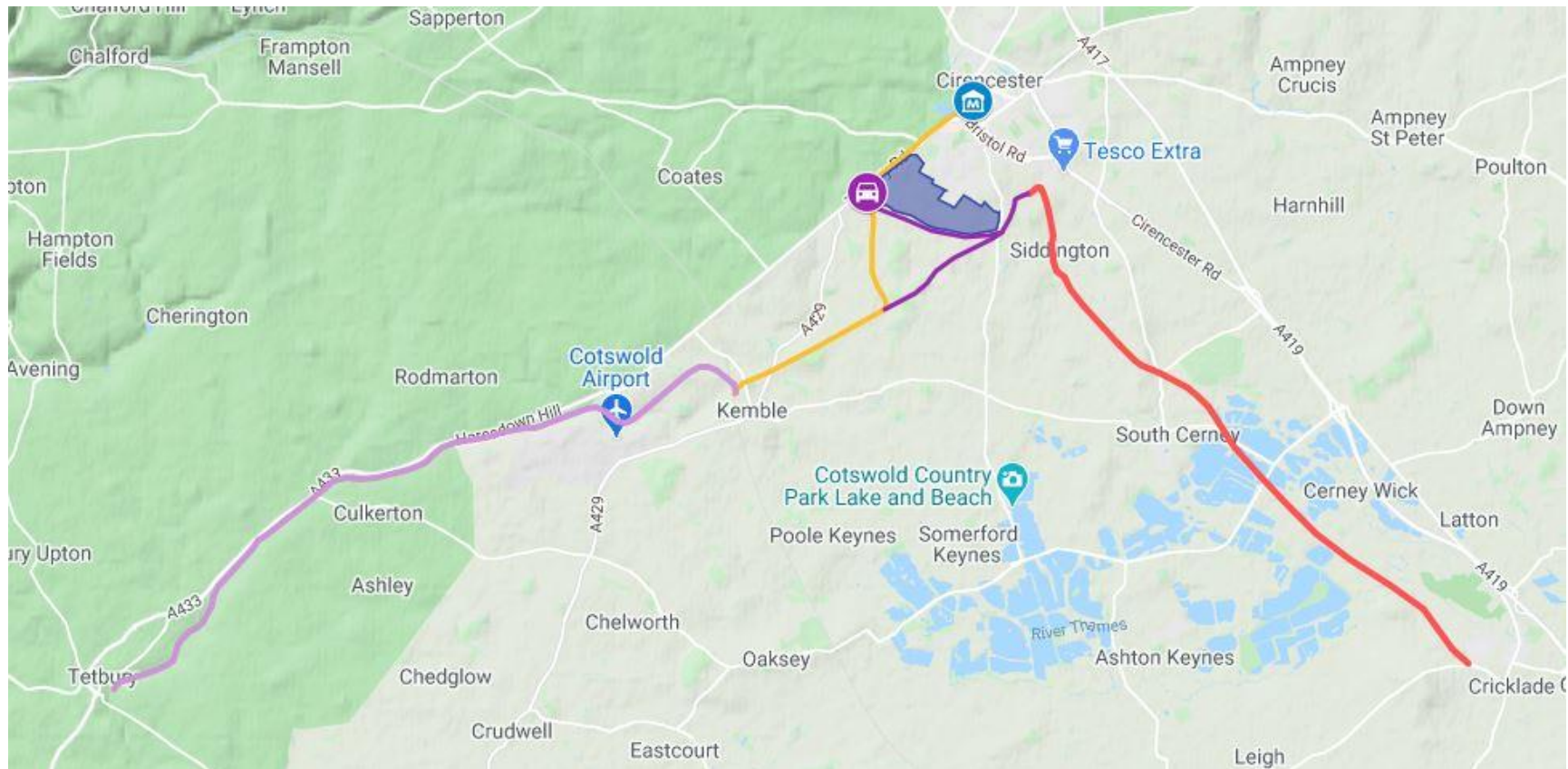

Cirencester Community Railway Next Steps

Cirencester Community Railway Project welcomes this opportunity to outline the project and its benefits to Cirencester and its Surrounding Area

We look forward to hearing your thoughts, comments and suggestions, with a view to optimising the plans to maximise the wins for everyone

Look out! Here it comes!

Richard Gunner, Chair
chair@CirenTrain.org.uk

visit CirenTrain.org.uk for more information

Cirencester Community Railway

These 4 pages are copied from the GFirst LEP Draft Local Industrial Strategy 2019

The current Landscape

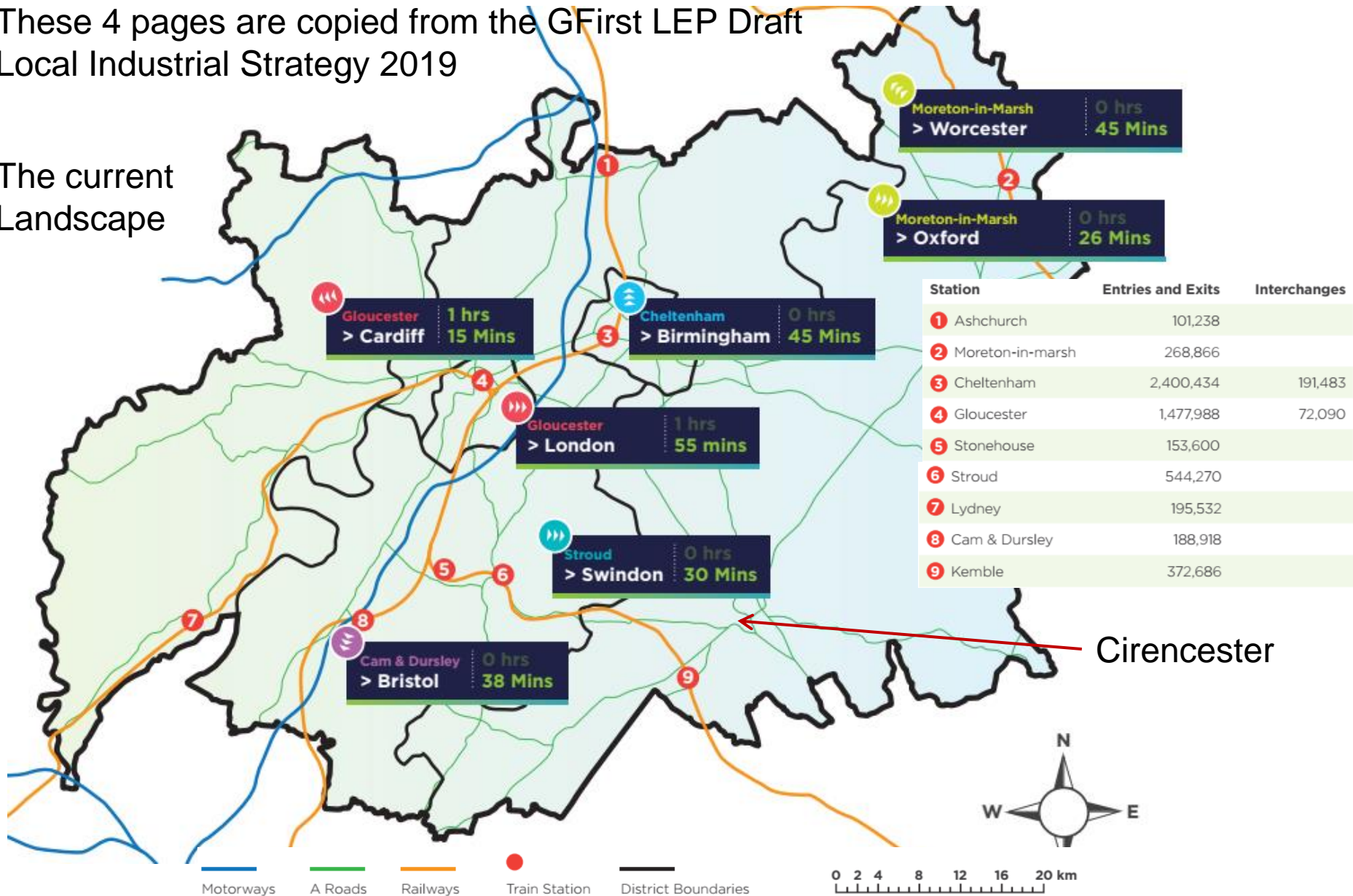

Cirencester

Cirencester Community Railway Building Recognition

Currently, over 80% of residents live and work within Gloucestershire⁷⁷ and there is pressure on the road networks and motorway junctions serving the county.

The limited availability of rural transport services has created a high car dependency, in part caused by infrequent or poor bus services in most rural areas. There is scope for a major cultural shift to capitalise on the take-up of electric vehicles, which is increasing rapidly across the UK.

Plans are in place to deliver around 60,000 additional new homes across the county by 2031, much of which is provided for in the Gloucester, Cheltenham and Tewkesbury Joint Core Strategy and, to a lesser extent, the Stroud local plan. This growth of the county's urban centres and surrounding areas contributes to an emerging Central Gloucestershire City Region.

Cirencester Community Railway

Building Recognition

Local transport policy

The Gloucestershire Local Transport Plan (LTP) sets out how it will manage the increased transport demand resulting from the projected new housing and accelerated economic growth, by working with the Joint Core Strategy and the local plans for Cotswold, Forest of Dean and Stroud.

The LTP focuses on the improved choice of mass transit options with interchange hubs for a combination of transport modes, active travel, walking and cycling. Gloucestershire is based on a geographical patchwork of travel corridors, each with its own transport opportunities and pressures.

We will need to work closely with sub-national transport bodies including the Western Gateway and Midlands Connect to exploit strategic road and rail corridors, and develop innovative public transport solutions that include walking and cycling.

This is relevant for new housing developments such as the garden towns and villages planned for the county which must be designed to encourage sustainable transport solutions. Page 68

Cirencester Community Railway

Building Recognition

Local transport policy

Promotion and use of alternatives to cars will contribute to a reduction in carbon emissions, help us achieve net zero by 2050, and help to place Gloucestershire at the forefront of improved sustainability.

We will provide the infrastructure needs highlighted by the county's young people including support for the natural environment as a 'green county' in which it is increasingly possible to move around easily without relying on a private car. Page 68

Rail study

The 2015 Rail Study Report for Gloucestershire outlines the recommended investments over the short, medium and long term. These include new stations to better serve where people live, whilst also proposing improvements to services at existing stations, which will deliver significant economic and financial benefits by making greater use of the existing rail infrastructure. GFirst LEP fully supports and is co-funding a new rail strategy for the county, due in 2019. Page 69

To develop a **rail strategy** to ensure that rail travel provides a viable alternative to the private car for travel within the county, between its key towns, and to other parts of the country. Page 73

Pages from GFirst LEP Local Industrial Strategy 2019

Cirencester Community Railway Building Recognition

